

UNCLASSIFIED
~~SECRET~~

SAND88-2268 Nuclear Weapon Data — Sigma 1
RS3151/88/108
Printed January 1989

Distribution
Category C-72

Interim Earth-Penetrator Weapon Test Series (U)

Paul Hooper and Richard Howell
B61-6,7,8/W61 Division
Sandia National Laboratories
Albuquerque, New Mexico 87185

Abstract (U)

A requirement exists to provide a weapon with an earth-penetrating capability. This type of weapon must survive high-velocity impact and subsequent penetration of various earth targets. To meet this requirement in the shortest possible time with minimum overall cost, a joint LANL/SNLA study was conducted to evaluate the feasibility of converting an existing stockpiled system into an earth-penetrating weapon (EPW). One specific weapon, the B61-7, was selected based on effectiveness, structural integrity, ease of modification, and compatibility with existing delivery systems. A series of six fully functional tests were conducted to demonstrate the utility of this system for a variety of target options and impact parameters. The results of the six tests are described and the overall capability of the EPW is discussed in this report.

CRITICAL NUCLEAR WEAPON DESIGN INFORMATION
DOD DIRECTIVE 5210.2 APPLIES.

~~RESTRICTED DATA~~ This document contains Restricted Data as defined in the Atomic Energy Act of 1954. Unauthorized disclosure subject to Administrative and Criminal Sanctions.

Classified by D. L. McCoy, Supervisor, B61-6, 7, 8 Division 5111,
August 3, 1988.

UNCLASSIFIED
~~SECRET~~

Contents

Introduction	7
Test Descriptions	8
Test Units and Instrumentation	15
Results	20
Comments and Conclusions	31
APPENDIX A – Drawing List	33
APPENDIX B – Hardware Trace	35
APPENDIX C – Impact Recorder Data	37
APPENDIX D – Photo-Optical Data	99
APPENDIX E – JTA Readouts	113
APPENDIX F – Mk-11 Rocket Test Specifications	121

Figures

1 Hellbender II Test Unit	9
2 Hellbender II Test Unit Mounted Under the DOE Twin Otter	10
3 Hellbender III Test Unit Suspended Under a CH53 Helicopter	11
4 Mk-11 Air-Drop Test Unit	12
5 Mk-11 Rocket Test Unit	13
6 Mk-11 Rocket on Launcher	14
7 Steel/Aluminum Penetrator Case Illustration	15
8 Hellbender II Pretest Hardware Photo	16
9 Hellbender II Posttest Hardware Photo	17
10 All-Steel Penetrator Case	18
11 Mk-11 Test Unit Illustration	19
12 Hellbender I Posttest Photo	20
13 Hellbender II Impact Crater	21
14 Hellbender II Subsurface Photo	22
15 Hellbender III Impact Site	23
16 Hellbender III Live IHE Posttest Inspection	24
17 Hellbender IV Impact Site	25
18 Mk-11 Air-Drop Test Impact Crater	26
19 Mk-11 Air-Drop Posttest Photo	27
20 Mk-11 Rocket Test Impact Crater	29
21 Mk-11 Rocket Posttest Photo	30
22 Mk-11 Rocket Posttest Residue	30
23 B61-7 Earth-Penetrator Test Unit Display	31

Tables

1 Test Summary	8
2 Test Unit Configuration Summary	19

Acknowledgments

The authors would like to recognize that this test series could not have succeeded without the diligent contributions from a sizable group of participants. Any credit for this project must necessarily be shared with all of the individuals in this group. Special appreciation should also be expressed to Los Alamos National Laboratory for significant contributions throughout the duration of this joint effort.

~~SECRET~~

Interim Earth-Penetrator Weapon Test Series

Introduction

The B61 gravity bomb was designed as a rugged laydown weapon that could accommodate a wide variety of high-performance aircraft and delivery conditions. Different versions of the B61 gravity bomb have been in production since the original B61-0 was built in 1968. In June 1985, the first production unit of the B61-7 version was completed. The B61-7 retrofit is a modified B61-1 with enhanced nuclear safety, use-control and operational flexibility features.

In November 1986, a proposal was made to adapt the B61-7 for use as an earth-penetrating weapon (EPW). The adaption involved modifying the weapon case to facilitate high-velocity head-on impact and subsequent penetration of various earth targets before weapon detonation.

Buried installations have been identified in the Soviet Union that were not easily challenged by the current nuclear stockpile.

adapt to modern, high-reliability delivery techniques. Note that for a given yield, a weapon will cause more damage to subsurface structures in an earth-penetrating mode than an air- or surface-burst mode.

Although the DOE Laboratories were already involved in on-going development of a high-performance Strategic Earth Penetrator Weapon (SEPW), the defense community expressed an interest in modifying an existing stockpile weapon for less cost and more immediate use. As a result, a series of tests were conducted to examine the feasibility of using the B61-7 as an EPW.

A total of six tests (Table 1) were conducted in parallel with a Phase 2 Interim Earth Penetrator study (*New Mexico Summary Documentation of Activities to Support the Feasibility of the Recommended Interim Earth Penetrator Warhead/Carrier Solution*, SAND88-2071). Four of the tests were conducted as simple drop tests and were given a Los Alamos National Laboratory (LANL) designator of "Hellbender." The other two were configured around a potential delivery vehicle and were designated as Mk-11 tests. This report documents the details of those six tests.

DOE
b(3)

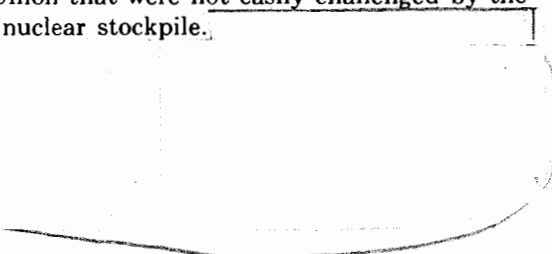

DOD
b(3)

~~SECRET~~

DOE
b(3)

DOE
b(3)

Test Descriptions

Hellbender I (R719500, 1/27/87)—The objective for the first Hellbender I test was to demonstrate that, with minimum structural modification, the B61-7 gravity bomb could survive and function as a modest (homogeneous soil) penetrator weapon. As a result, this test was devised so that a B61-7 test unit would impact into a moderately hard soil structure at a suitable velocity for penetration and energy coupling. The specific test parameters were judged to be the minimum levels that would be useful for an interim EPW.

To implement this test, a B61-7 development unit was modified to accept a steel nosecone in place of the standard energy-absorber radar nose. The parachute retard system was removed, and the tail section was modified to accommodate vertical suspension from the underside of a helicopter. The test unit was then dropped, free-fall, onto a dry lake bed known as Antelope Lake at the Tonopah Test Range (TTR).

The B61-7 electrical system was preset in the long laydown-timer mode so firing set arming and firing would occur after the unit came to rest in the ground.

DOE
b(3)

Specific hardware, instrumentation, and test results are described in a later section of this report.

Hellbender II (R719505, 6/17/87)—Although many of the perceived underground targets could be held at risk with a simple soil penetrating weapon, a second test was devised to further demonstrate the utility of the B61-7 against the same targets during the winter season. The parameters for the Hellbender II test were therefore chosen to simulate the environment that the test unit (Figure 1) would encounter when impacting a deeply frozen-soil target.

A very hard location at TTR known as Brown's Lake was selected as the simulated frozen target. Although the dry lake bed was not actually frozen during the test, terradynamic calculations showed that it was considerably harder to penetrate than a typical soil target frozen to a depth of 6 ft.

The impact velocity for Hellbender II was also increased; more carrier/delivery options appear to be available to this system if it could survive at a higher-impact velocity. To achieve a higher-impact velocity, the test unit had to be dropped from 17,000 ft above sea level. This requirement eliminated the use of a helicopter as the drop vehicle.

As a result, this test was designed for delivery from the DOE Twin Otter airplane (Figure 2). This style of delivery resulted in a more shallow impact angle than a helicopter drop because of the higher forward velocity at release. As before, the unit was configured so that the arming, fuzing, and firing (AF&F) system functioned after it came to rest in the ground.

3) was essentially the same as the previous tests and, as before, the B61-7 electrical system was functioned in the ground using the timer-delay fusing option.

DOE
(3)

A faulty helicopter release mechanism caused the B61-7 AF&F system to function in captive flight before release. Although the electronics did not actually operate in the ground, component survival was confirmed by a posttest electrical bench checkout in the laboratory.

A helicopter was again used for the drop vehicle to achieve a near 90° impact angle. The test unit (Figure



Figure 3. Hellbender III Test Unit Suspended Under a CH53 Helicopter (LANL RN88-28-14)

Test Units and Instrumentation

Hellbender I—Although the B61-7 gravity bomb was built for low-altitude, high-speed drops on hard irregular targets, it cannot survive earth penetration environments without modification. Primarily, the B61 aluminum honeycomb radar nose is designed to mitigate laydown shock by crushing up. This would create an unacceptable blunt shape for earth penetration.

For the first Hellbender test, the only major change to the standard bomb test unit was the substitution of a rugged conical nose for the crushable radar nose (Figure 7). The penetrator nose was machined from a heat-treated billet of HP-9-4-20 steel. This steel was selected over other available materials because of its high strength and fracture toughness.

The nose was designed to adapt to the aluminum center case using two tape joints. Two parallel joints were required for optimum strength because radial clearance was limited. Two mating tape grooves were machined into the center case to accommodate this double tape joint. The observation window in the center case was replaced with a steel plate. A list of all unique earth penetrator hardware that was fabricated for this program is included in the appendix.

An interface control unit (ICU) was attached to the aft cover plate. The preflight controller and spin rocket were deleted from the preflight case. Likewise, the tail case was empty except for a pullout actuator mounted facing aft.

Kevlar straps were looped around the shroud line attachment ring so that the test unit could be suspended vertically from underneath a helicopter. Note that the heavy steel nose and empty tail case resulted in an excellent static margin during free-fall.

All critical firing signals were monitored by an on-board JTA flight recorder. A special data recorder was installed inside the steel nose to record the penetration environment (Figure 7). It monitored four strain gages on the inside wall of the steel nose and a single axial accelerometer mounted inside the recorder. The strain gages were mounted 24.5 in. from the tip of the conical nose. The package was designed to trigger when it sensed a certain minimum acceleration. That threshold was set at such an arbitrarily high value (100 g) that it could only be initiated by a high-velocity impact.

Since both the JTA flight recorder and the impact recorder were nonradiating devices, the memory modules could not be interrogated until the test unit had been recovered.

Tonopah Test Range (TTR) provided complete radar tracking and photometric coverage of the drop test including an array of fixed cameras for high-resolution impact information. A CH53 US Marine Corps Helicopter was used to drop the test unit.

DOE
b(3)

DOE
b(3)

DOE
b(3)

DOE
b(3)

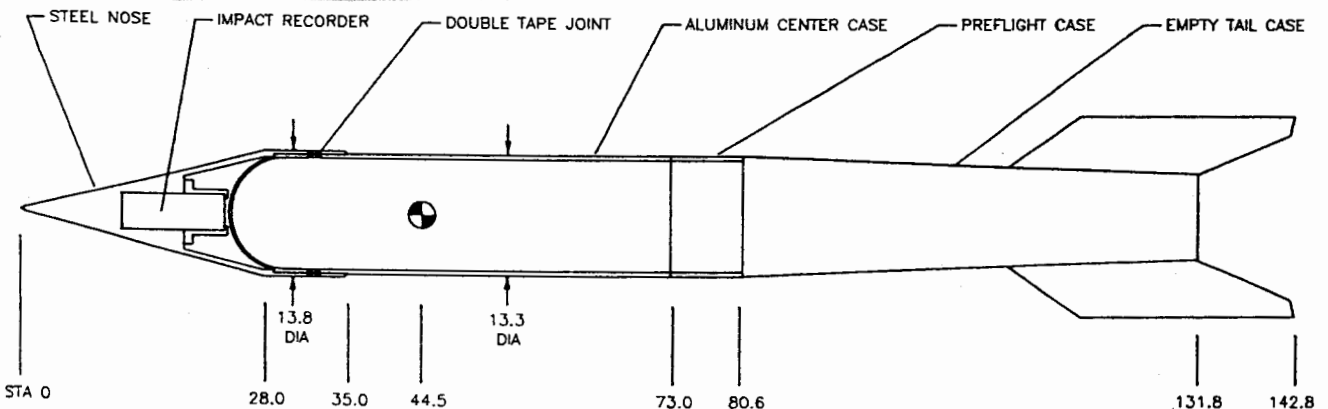
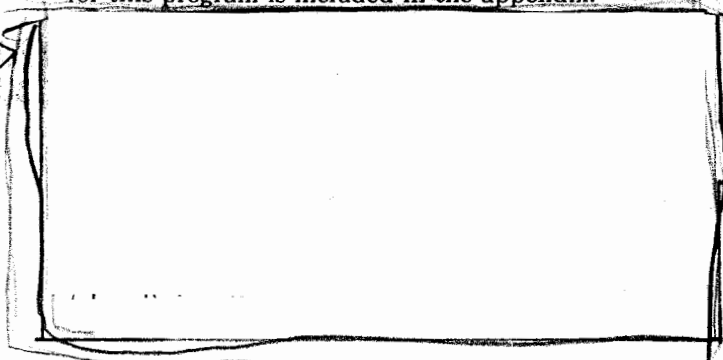

Figure 7. Steel/Aluminum Penetrator Case Illustration

Hellbender II—With only a few exceptions, the Hellbender II test unit (Figure 8) was identical to Hellbender I. The steel nose and aluminum center case were both repainted. All of the AF&F components in the center case were reused except expended items, batteries and explosive actuators.

The same JTA flight recorder was again used to verify correct operation of critical firing signals. Also, the same impact recorder was installed in the steel nose. Unlike the first test unit, the strain gages were moved to a point 11 in. forward of the aft edge of the center case (Station 62.0). This region exhibited a simpler geometry for stress calculations. In addition to the built-in axial accelerometer in the data package, a triaxial accelerometer was mounted to the firing set. Historically, this is a standard reference point for B61 component response measurements.

The unit was dropped from the DOE Twin Otter airplane. TTR again furnished complete radar and photometric coverage of the test (Figure 9).

main detonators were not connected to the firing set in an effort to preserve any damage induced by the penetration environment. All preflight and tail components were omitted except the pullout actuator and a set of JTA flashers. These were installed in the tail to get accurate time-of-release information.

DOE
(3)



Figure 10. All-Steel Penetrator Case (C88-1616)

Mk-11 Air Drop—The test units (Figure 11) for the Mk-11 test series were significantly different from the Hellbender drop vehicles. To fit inside the Mk-11C reentry shell, the conical steel-nose design had to be shortened about 6 in. The new steel nose was filled with a 315-lb depleted uranium ballast for mass property considerations. The result was a slight ogive profile compared to the conical Hellbender nose

DOE
b(3)

The AF&F system was composed of fully functional components and the standard JTA flight recorder. Because of weight and center-of-gravity constraints, the ICU was replaced by a small simulator box.

The standard Mk-11C aerodynamic shell was modified slightly for this test. Externally, the composite skin was machined down to the bare-heat shield for proper reentry simulation. Internally, the substructure was cleaned out to accept penetrator mounting features including an axial nose cup, a lateral center-case ring, and a rigid aluminum support cone. To provide area support for the Mk-11 shell, the void between the penetrator and the shell was filled with a dense (32 lb/ft³) polyurethane foam. The normal Mk-11 spin rockets were used for spin stabilization of the vehicle. The mating spacer section was attached to the test unit to accommodate parachute extraction from the cargo bay of the C-130 aircraft. Standard Mk-11 gas-actuated ball locks were used to attach the spacer to the reentry body.

A special telemetry system was designed to transmit in-flight vehicle dynamics information. It was mounted on an annular plate between the penetrator and the aerodynamic shell. The system monitored a triaxial accelerometer, two magnetometers and a triaxial rate-gyro. The same circuitry was used to fire the ball locks spin rockets, and to initiate the B61 electronics. The telemetry package was lanyard-initiated during parachute extraction from the C-130. It also incorporated several safety provisions to preclude premature actuation while in the C-130 cargo bay.

The free-fall vehicle was spin-balanced prior to

quence was tracked and photographed by TTR. Since the drop technique was not precise, no fixed-ground cameras were used. Because of schedule constraints, the impact recorder was not included in this test unit.

Mk-11 Rocket Test—The test unit for the Mk-11 Rocket test was similar to the vehicle used in the air-

The steel nose was cleaned off and reused. The functional AF&F system was installed along with the same JTA flight recorder

DOE
b(3)

DOE
b(3)

DOE
b(3)

A second Mk-11C aerodynamic shell was modified for proper reentry simulation and penetrator mounting features. All new hardware was fabricated for mounting the penetrator inside the shell.

A new in-flight telemetry was designed to accommodate unique rocket system functions. In addition to monitoring the same set of dynamics instrumentation,

the circuitry was used to separate rocket motors, fire the second stage rocket, release the test vehicle, turn on the B61 electronics, initiate the impact recorder, and start a special flight stabilization device. The telemetry package also transmitted general diagnostic information and provided rocket-safing features, including an environmental-sensing switch.

SECRET

UNCLASSIFIED

The stabilization device was called an Active Rate Reducer (ARR). It used high-pressure nitrogen to create counter thrust that would damp out instabilities during flight. It was delivered as a complete assembly (including gas bottles) from the missile-contracting agency. A 50-lb lead ballast was mounted in the nose of the Mk-11 shell to offset the weight of the ARR package on the aft cover.

trajectory was not predictable enough to warrant the use of a fixed-impact camera array.

Results

TTR furnished complete radar and photometric coverage excluding fixed-ground cameras. The rocket

DOE
b(3)

DOE
b(3)

DOE
b(3)

SECRET

UNCLASSIFIED

~~SECRET~~

UNCLASSIFIED

DOE
b(3)

Although the all-steel case was badly scratched,

DOE
b(3)

DOE
b(3)

DOE
b(3)

DOE
b(3)

DOE
b(3)



Figure 17. Hellbender IV Impact Site (C88-4400)

~~SECRET~~

UNCLASSIFIED

Mk-11 Rocket Test—The Mk-11 Rocket Test was the most complex test in this series. The Mk-11 test vehicle was launched into a ballistic trajectory using a Talos rocket motor. The second stage, improved Honest John motor was fired several seconds after apogee to accelerate the payload to a realistic reentry velocity. The Mk-11 test unit separated smoothly from the rocket motor and gradually decelerated through the critical transsonic regime. The Active Rate-Reducer (ARR) mechanism was activated at separation and operated throughout the free-fall.

The actual trajectory was lower (41 kft vs. 47 kft), shorter (48 kft vs. 62 kft) and quicker (78.2 sec vs. 92.5 sec) than predicted.

DOE
b(3)

The short flight was probably caused by a 6% to 7% thrust degradation because of the age of the Talos rocket motor. The free-flight of the Mk-11 was too abbreviated to draw firm conclusions about the vehicle stability but the severe impact conditions were excellent for testing penetrator survivability.

DOE
b(3)

DOE
b(3)

The aft end of the Mk-11 shell came to rest in the soil about 6 in. below the surface (Figure 20). This suggests that the aero structure did not remain attached to the payload very long and probably had a negligible effect on penetration performance. A complete deceleration record would have helped to quantify this effect. Photometric coverage during the flight was excellent (Figures 21 and 22).

DOE
b(3)

DOE
b(3)

AAAM

UNCLASSIFIED

DOE b(3)

Comments and Conclusions

All of the Hellbender and Mk-11 test objectives were met. The cumulative data that were collected during this test series demonstrate that the B61-7 gravity bomb (Figure 23) can be modified to perform as an earth-penetrating weapon (EPW).

The Hellbender and Mk-11 test series successfully demonstrated the potential utility of the B61-7 gravity bomb as an EPW. This does not imply that the B61-7 is currently certified to be used in this type of application. Some of the longitudinal shock levels that were measured during this series did exceed the current gravity bomb requirements. In the event that a B61 earth-penetrator development program is authorized, a more rigorous technique for component certification will have to be devised.

DOE
b(3)



Figure 23. B61-7 Earth-Penetrator Test Unit Display (C88-3897)

AAAM

UNCLASSIFIED

~~SECRET~~ UNCLASSIFIED

HB-1 Helicopter Air Drop Strain at 0 Degrees

Analog LPF: 4800 Hz
Digital LPF: none

Test Date
01-27-87

SSP-85

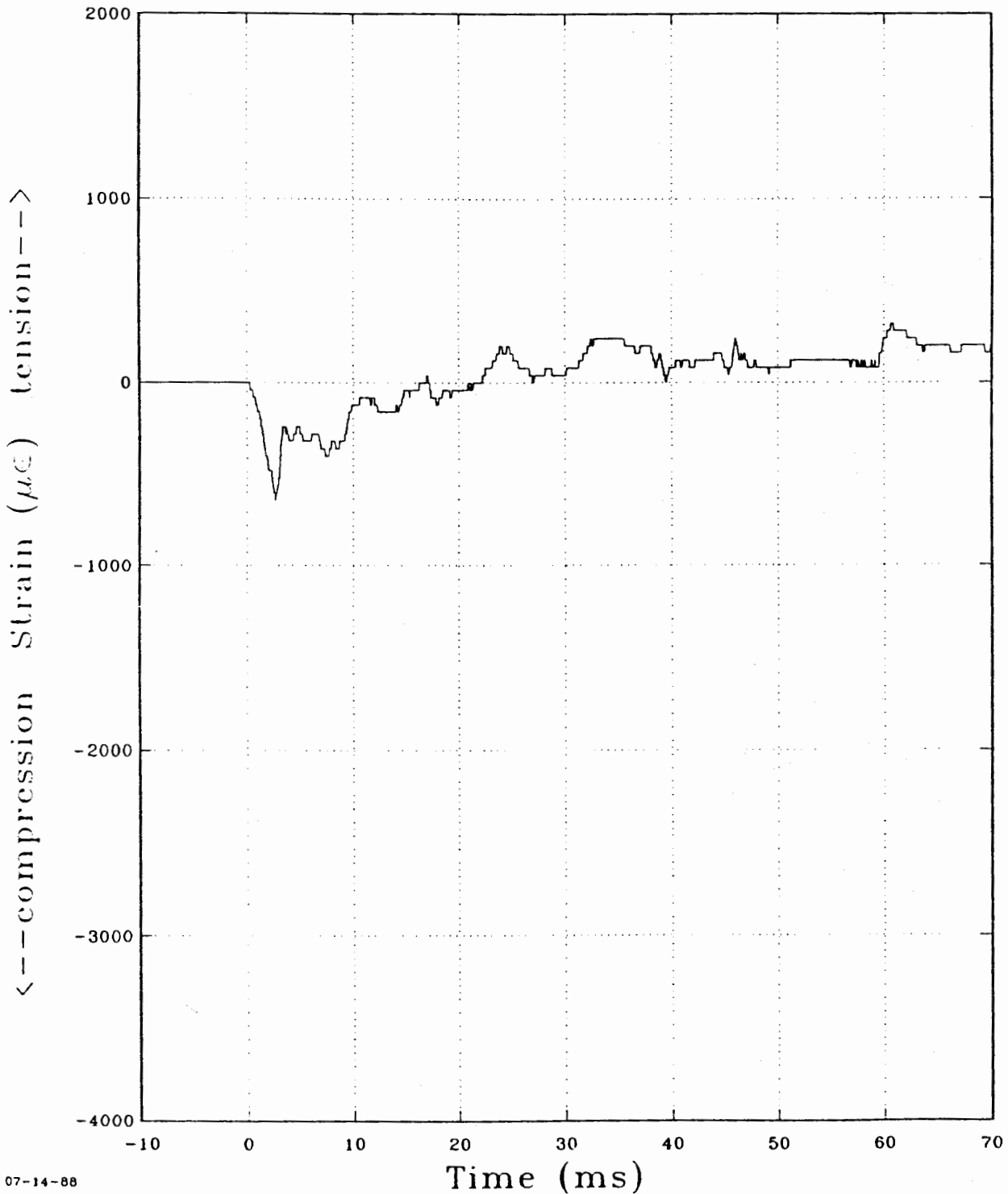

07-14-88

SNLA
5144

~~SECRET~~ UNCLASSIFIED⁴¹

HB-I EPW Helicopter Air Drop

Strain at 90 Degrees

Analog LPF: 4800 Hz
Digital LPF: none

Test Date
01-27-87

SSP-85

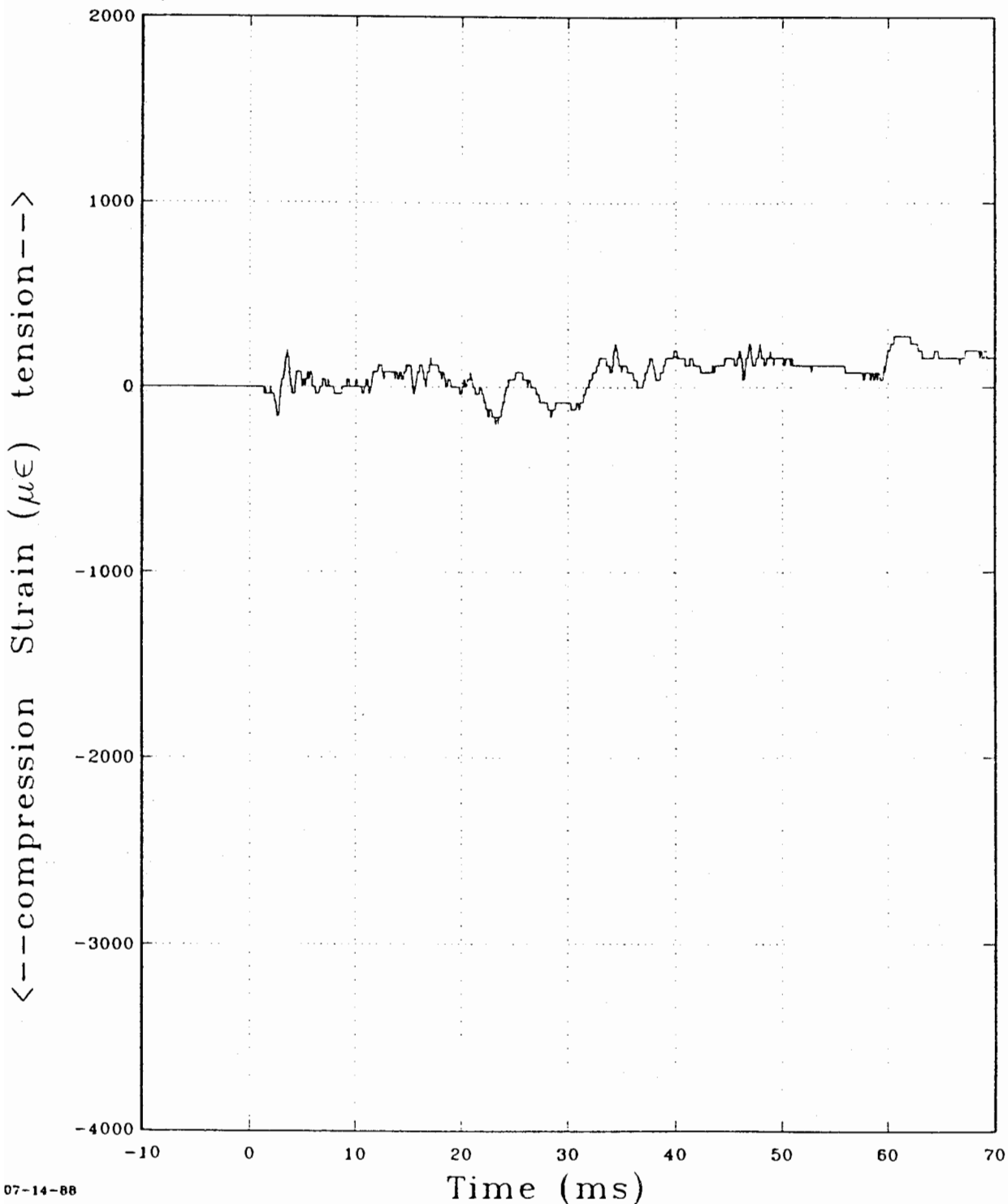

07-14-88

SNLA
5144

~~SECRET~~

UNCLASSIFIED

HB-1 Helicopter Air Drop Strain at 180 Degrees

Analog LPF: 4800 Hz
Digital LPF: none

Test Date
01-27-87

SSP-85

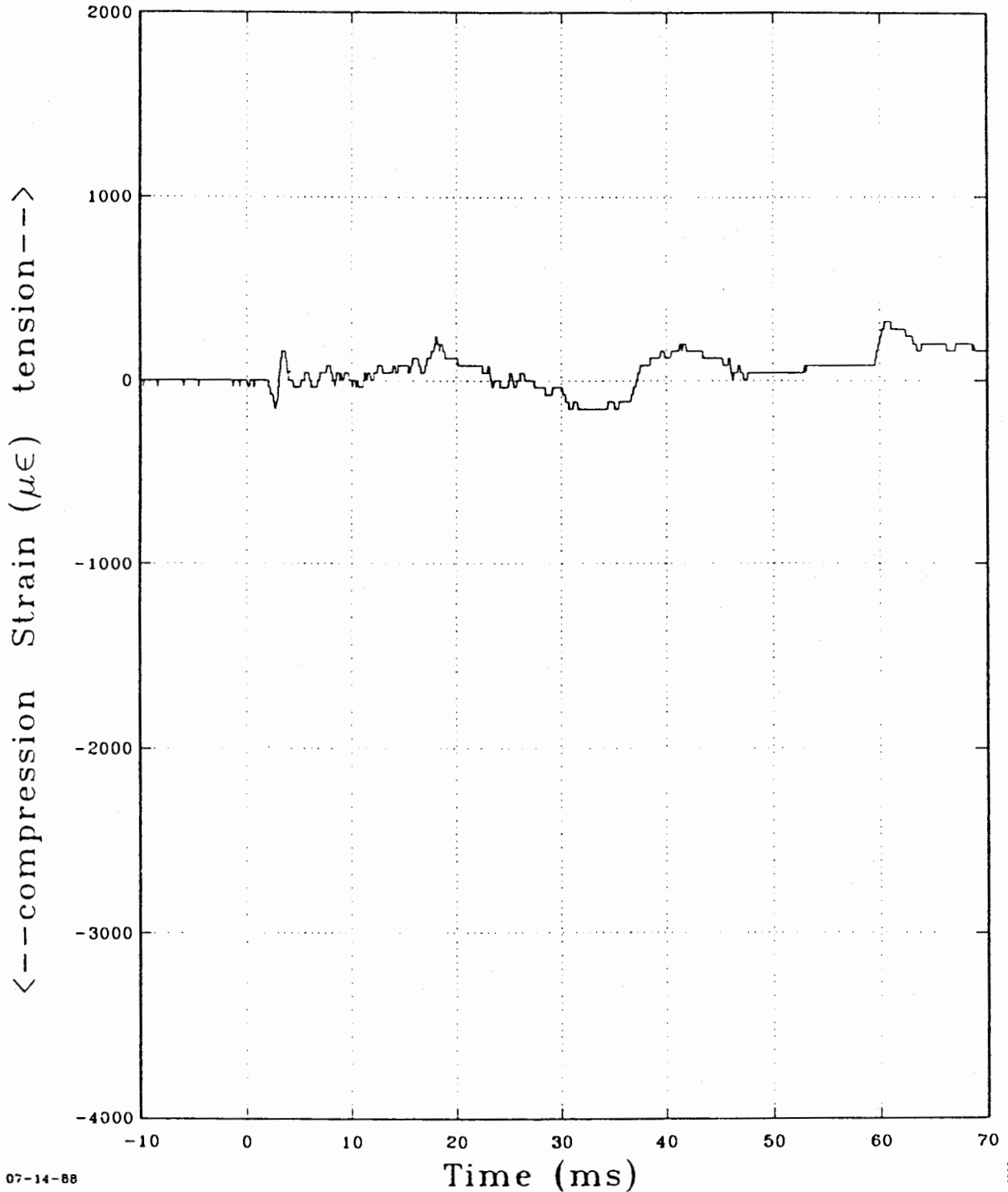

07-14-88

SNLA
5144

~~SECRET~~

UNCLASSIFIED 43

~~SECRET~~

UNCLASSIFIED

HB-I Helicopter Air Drop Strain at 270 Degrees

Analog LPF: 4800 Hz
Digital LPF: none

Test Date
01-27-87

SSP-85

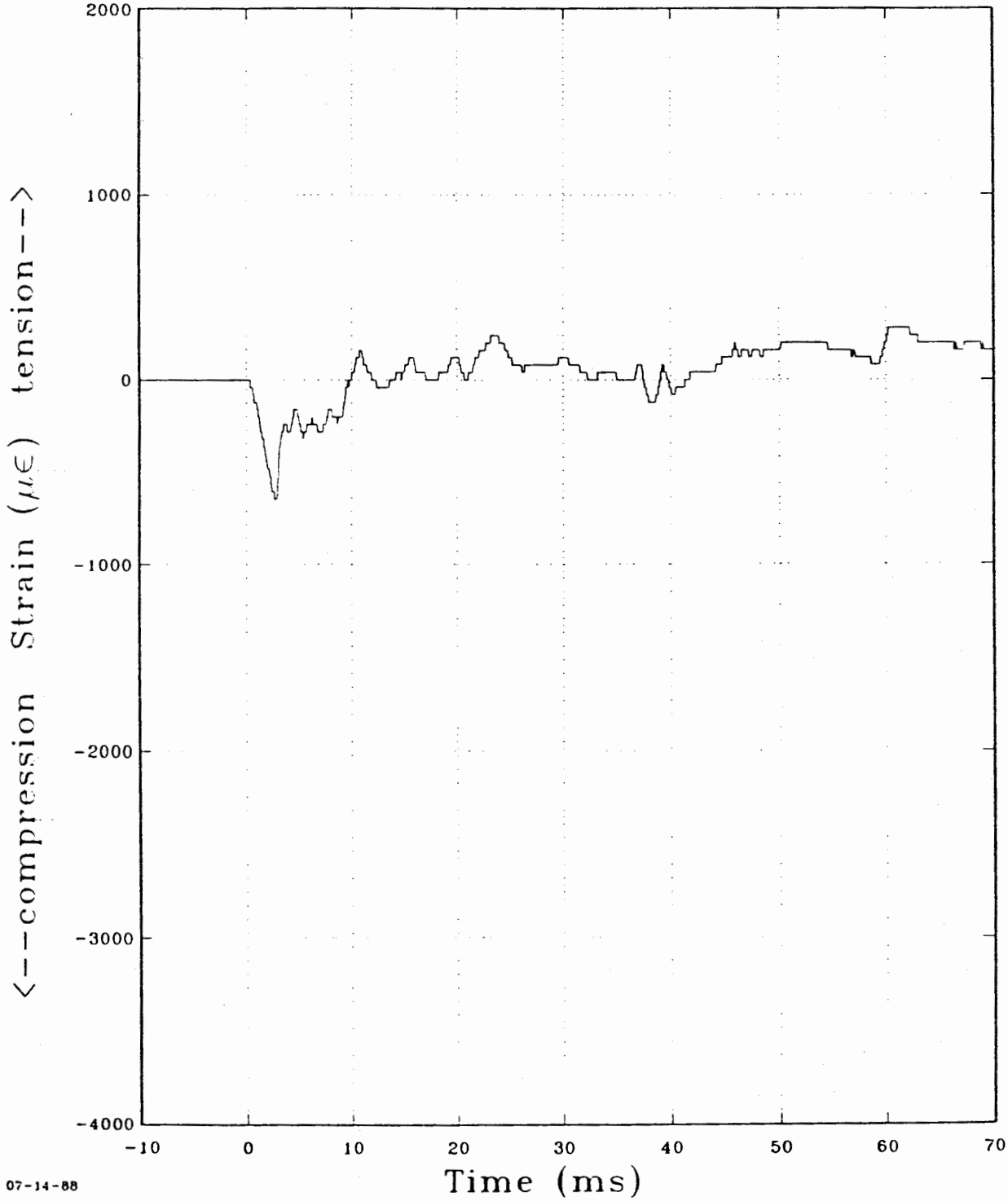

07-14-88

SNLA
5144

~~SECRET~~

UNCLASSIFIED

~~SECRET~~

UNCLASSIFIED

HB-1 Helicopter Air Drop

Axial Strain

(0 degrees + 180 degrees)/2

Analog LPF: 4800 Hz
Digital LPF: none

Test Date
01-27-87

SSP-85

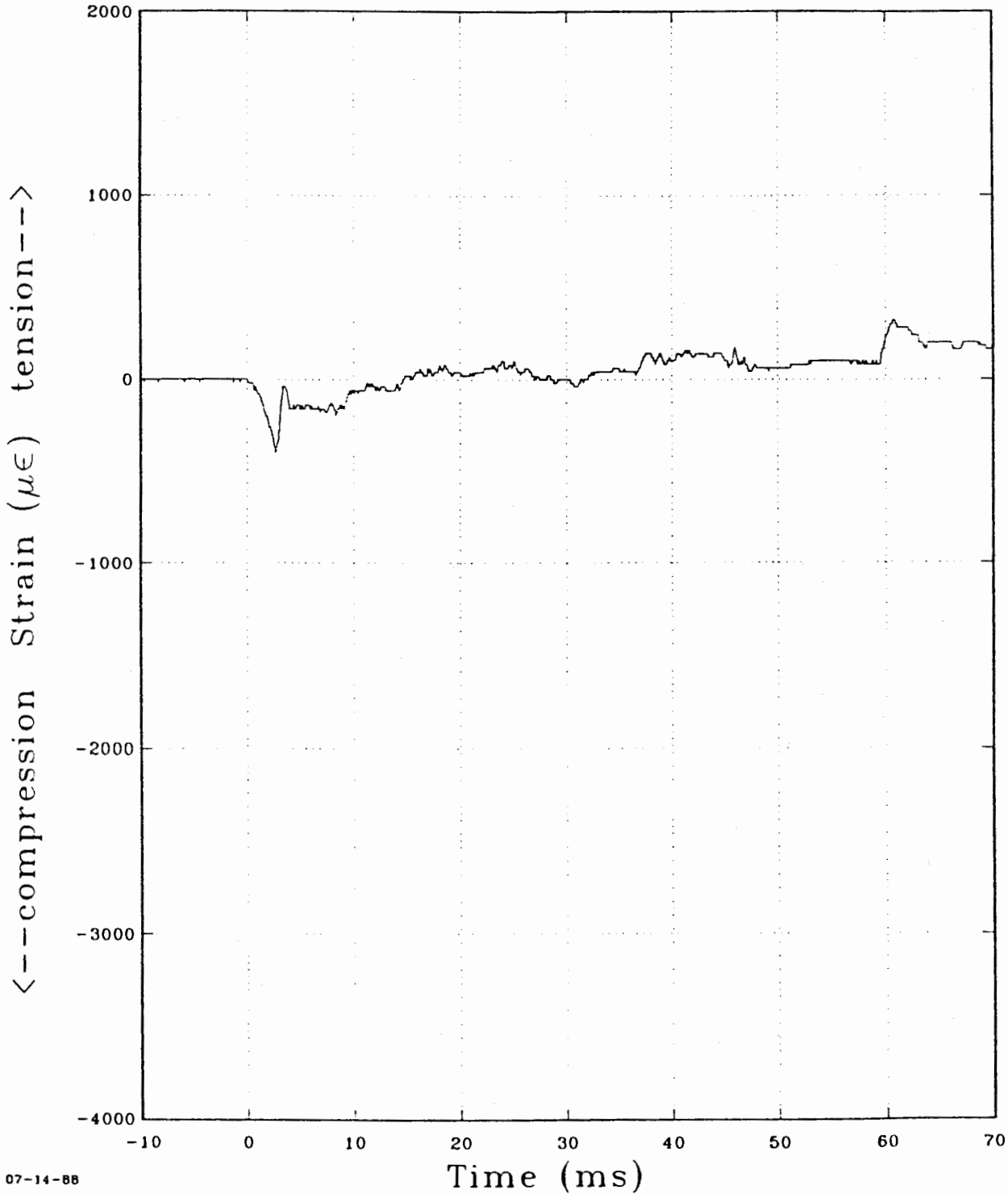

07-14-88

SNLA
5144

~~SECRET~~

UNCLASSIFIED

~~SECRET~~

UNCLASSIFIED

HB-1 Helicopter Air Drop Bending Strain (0 degrees - 180 degrees)/2

Analog LPF: 4800 Hz
Digital LPF: none

Test Date
01-27-87

SSP-85

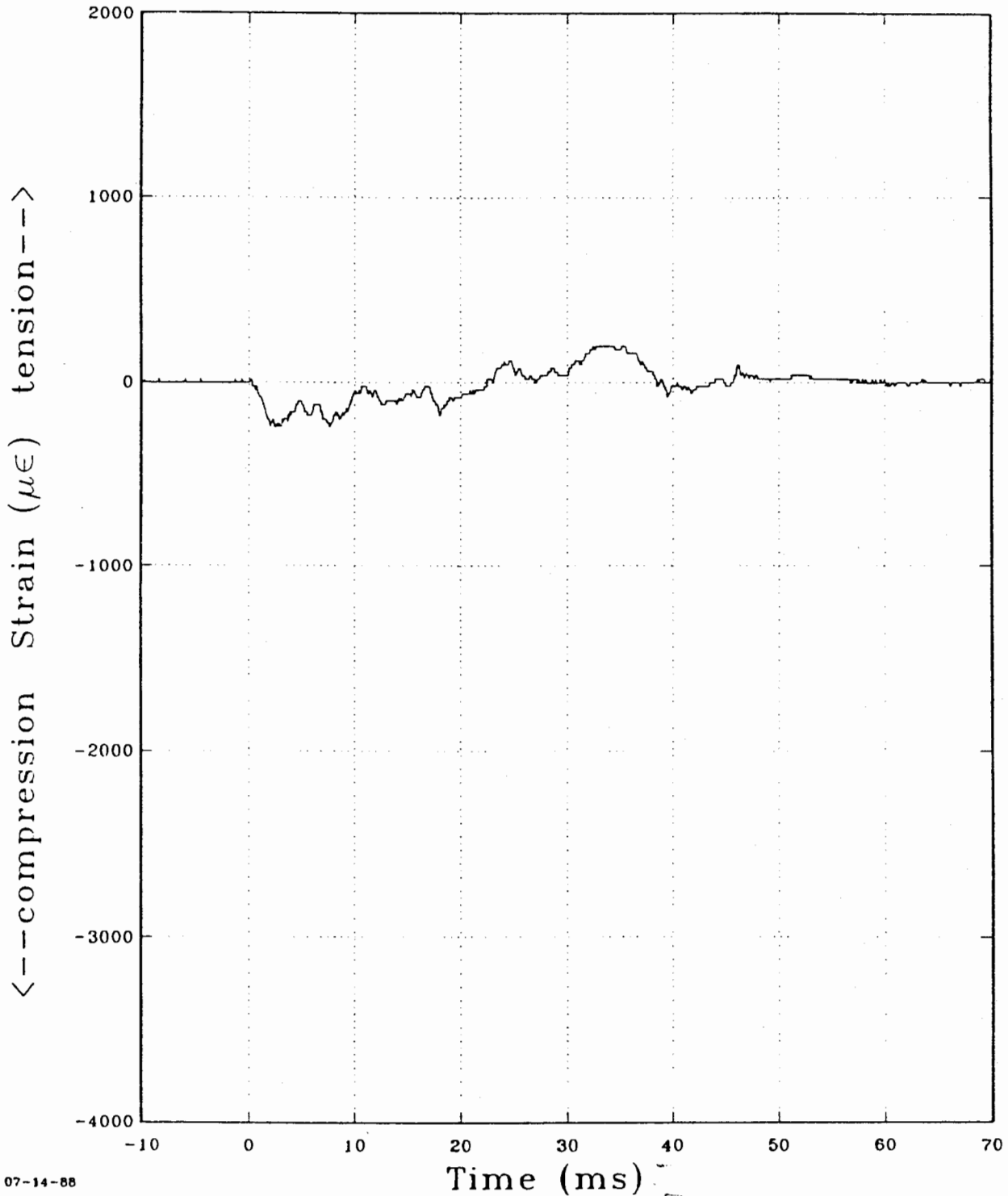

07-14-88

SNIA
5144

~~SECRET~~

UNCLASSIFIED 47

~~SECRET~~

UNCLASSIFIED

HB-1 Helicopter Air Drop
Bending Strain
(90 degrees - 270 degrees)/2

Analog LPF: 4800 Hz
Digital LPF: none

Test Date
01-27-87

SSP-85

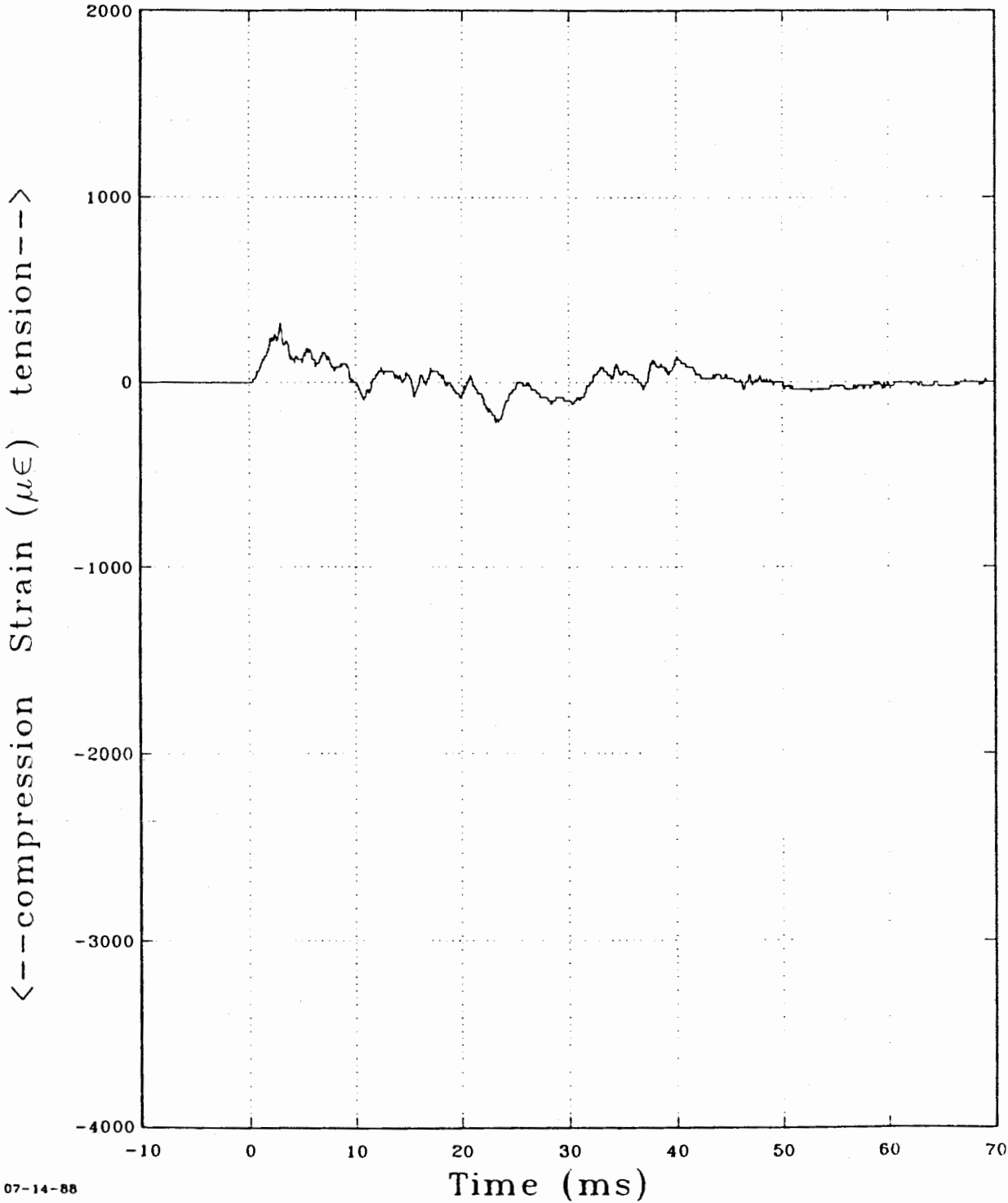

07-14-88

SNLA
5144

~~SECRET~~

UNCLASSIFIED

~~SECRET~~

UNCLASSIFIED

HB-II Otter Air Drop

Strain at 0 Degrees

Analog LPF: 4800 Hz
Digital LPF: none

Test Date
06-19-87

W61-2
SSP-85

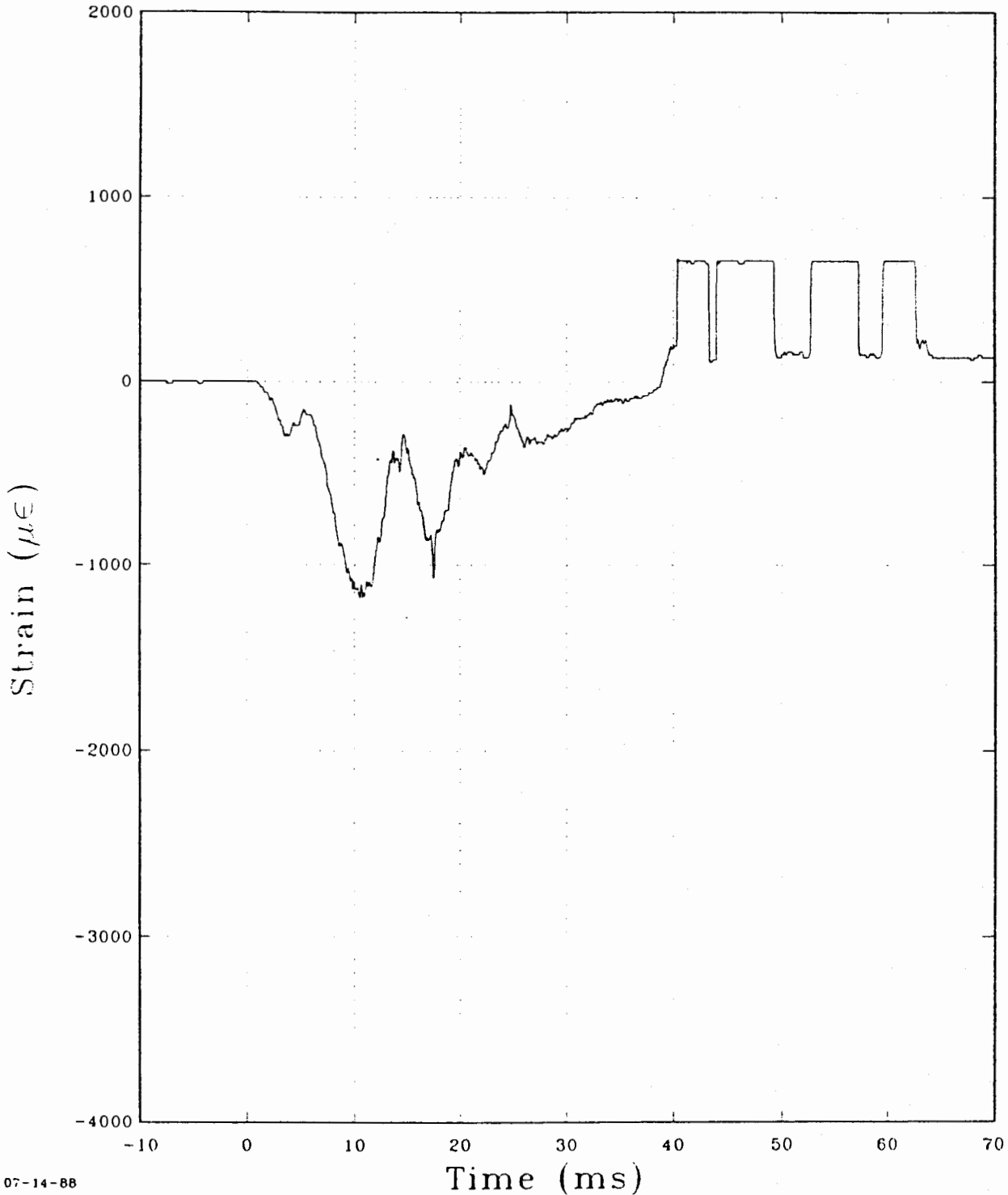

07-14-88

SNA
5111

~~SECRET~~

UNCLASSIFIED

~~SECRET~~

UNCLASSIFIED

HB-II Otter Air Drop Strain at 90 Degrees

Analog LPF: 4800 Hz
Digital LPF: none

Test Date
06-19-87

W61-2
SSP-85

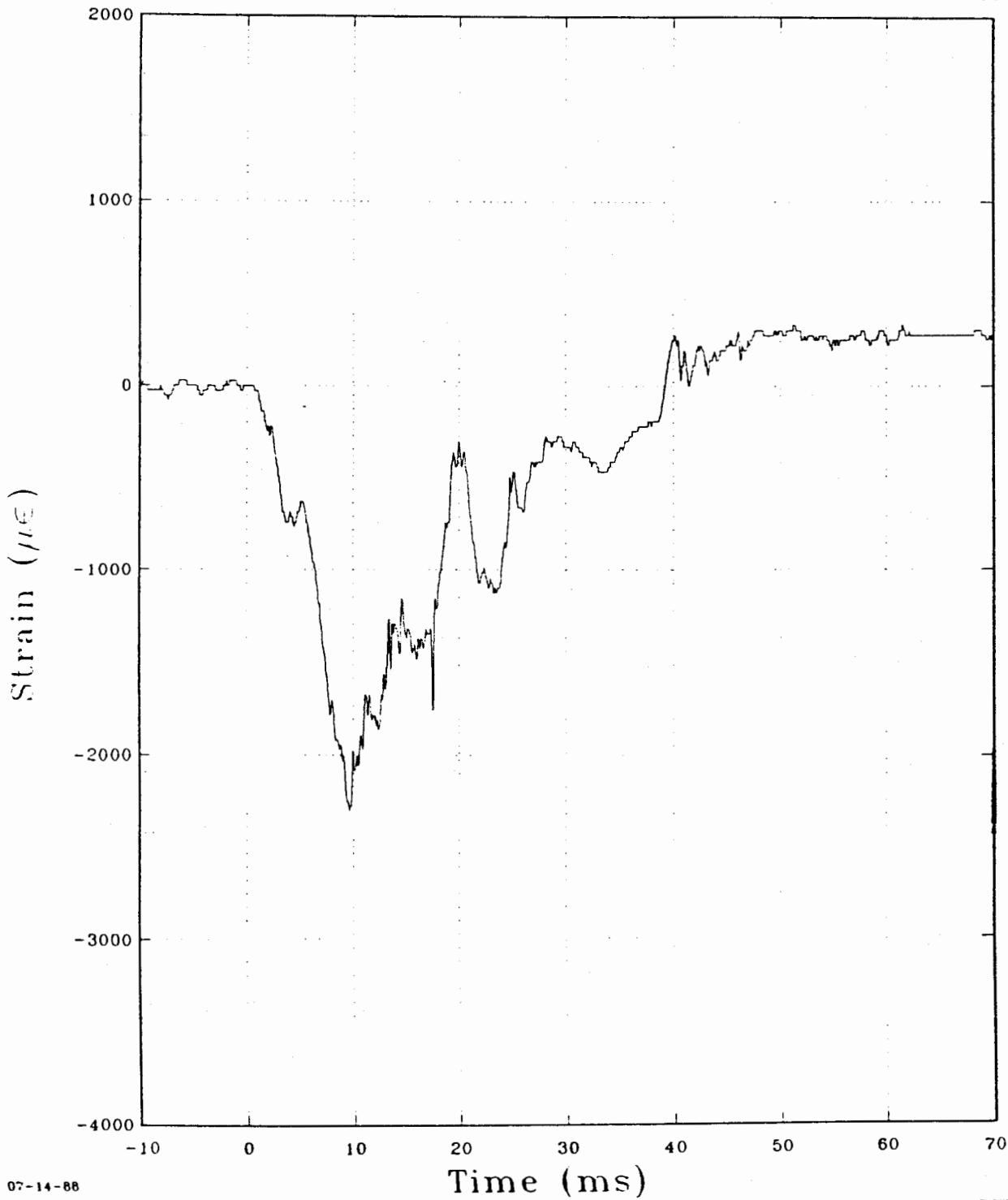

07-14-88

SNIA
5143

~~SECRET~~

UNCLASSIFIED

~~SECRET~~

UNCLASSIFIED

HB-II Otter Air Drop Strain at 270 Degrees

Analog LPF: 4800 Hz
Digital LPF: none

Test Date
06-19-87

W61-2
SSP-85

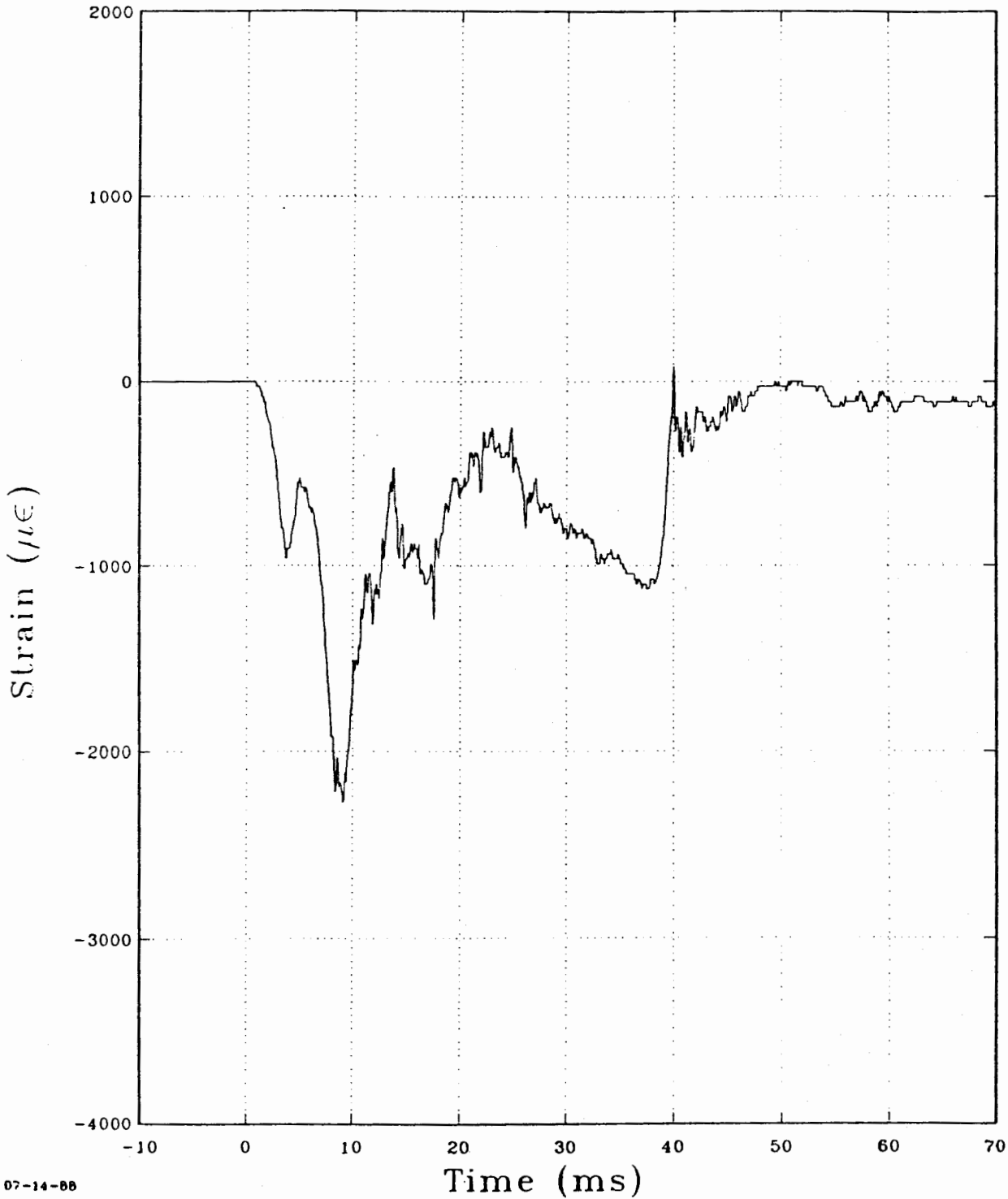

07-14-88

SNIA
5144

~~SECRET~~

UNCLASSIFIED

~~SECRET~~

UNCLASSIFIED

HB-II Otter Air Drop
Axial Strain
(0 degrees + 180 degrees) / 2 -

Analog LPF: 4800 Hz
Digital LPF: none

Test Date
06-19-87

WG1-2
SSP-85

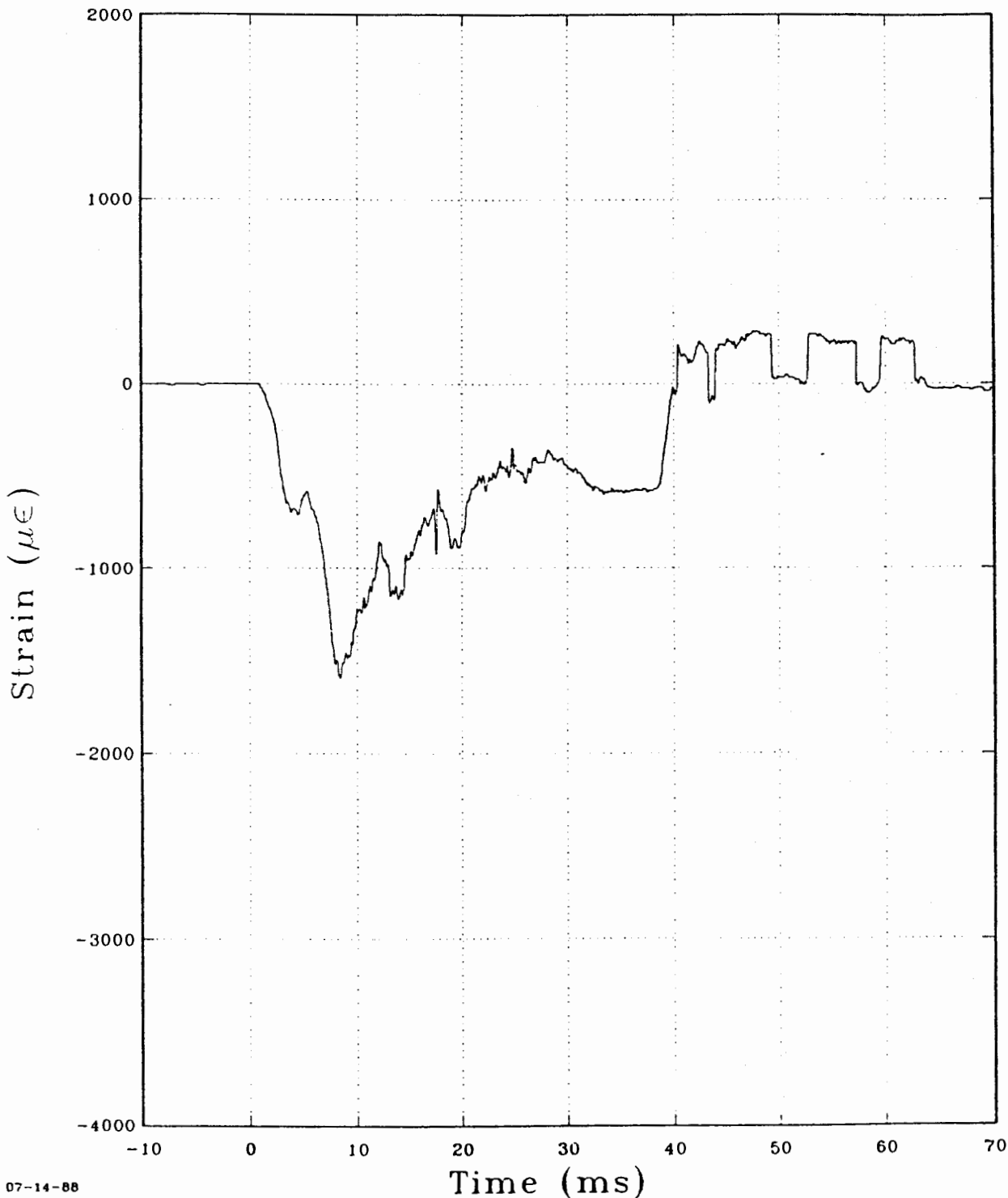

07-14-88

SNIA
5141

~~SECRET~~

UNCLASSIFIED

AAAL

UNCLASSIFIED

HB-II Otter Air Drop Axial Strain

(90 degrees + 270 degrees) / 2

Analog LPF: 4800 Hz
Digital LPF: none

Test Date
06-19-87

W61-2
SSP-85

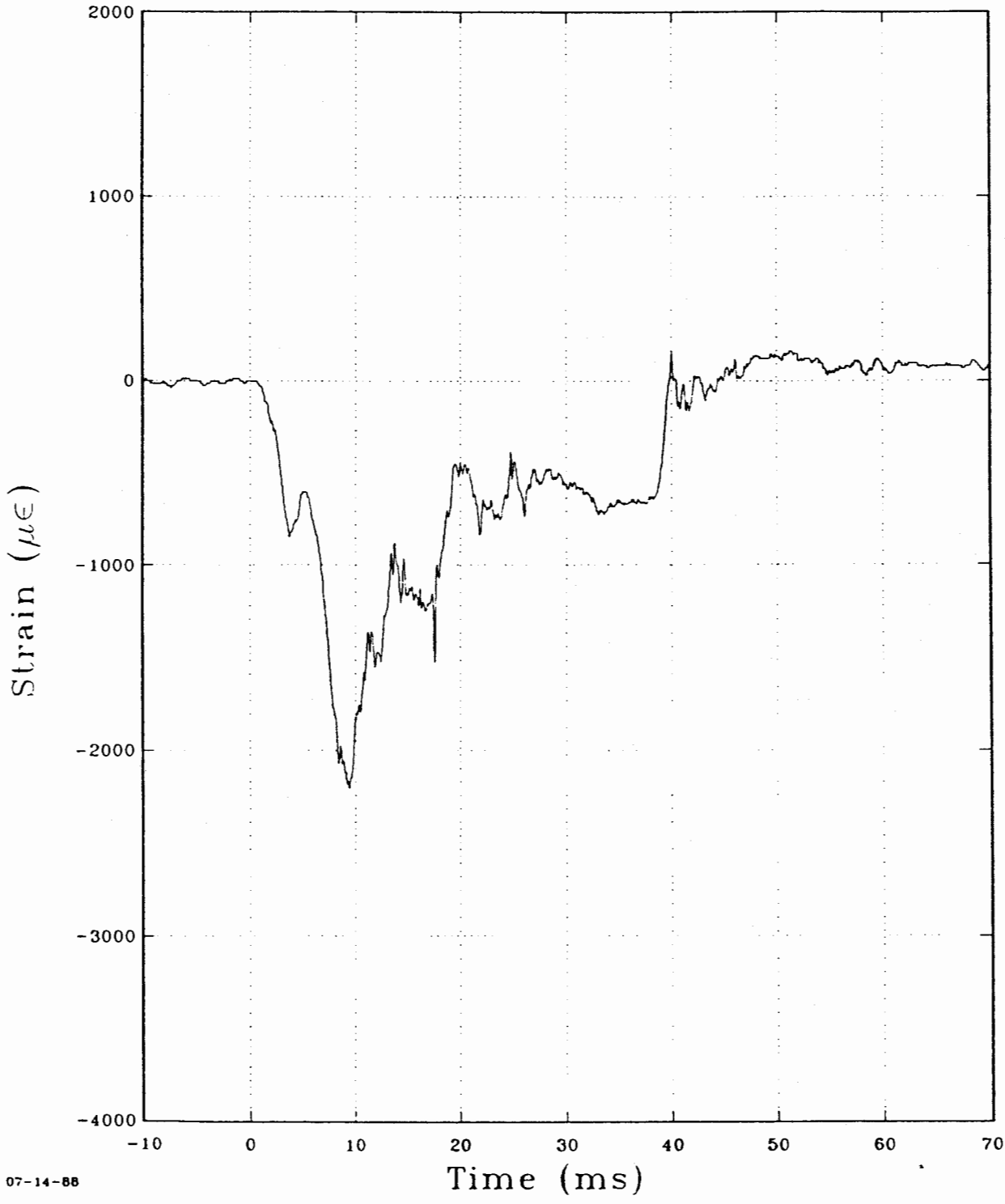

07-14-88

SNLA
5144

AAAL

UNCLASSIFIED

~~SECRET~~

UNCLASSIFIED

HB-II Otter Air Drop Bending Strain

(90 degrees - 270 degrees) / 2

Analog LPF: 4800 Hz
Digital LPF: none

Test Date
06-19-87

W61-2
SSP-85

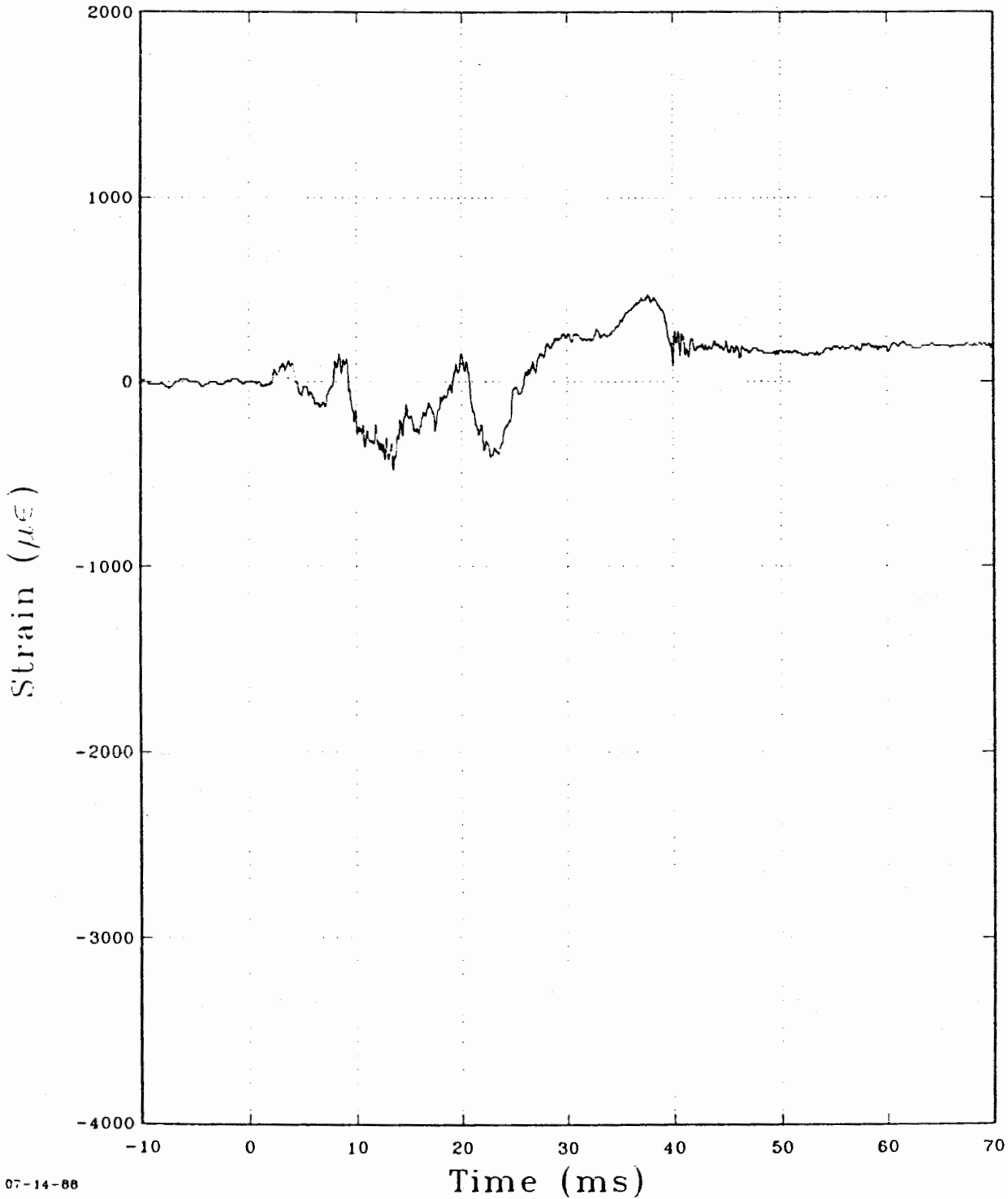

07-14-88

SNLA
5144

~~SECRET~~

UNCLASSIFIED

~~SECRET~~ UNCLASSIFIED

HB-III Helicopter Air Drop Strain at 0 Degrees

Analog LPF: 4800 Hz
Digital LPF: none

Test Date
02-12-88

W61-3
SSP-85

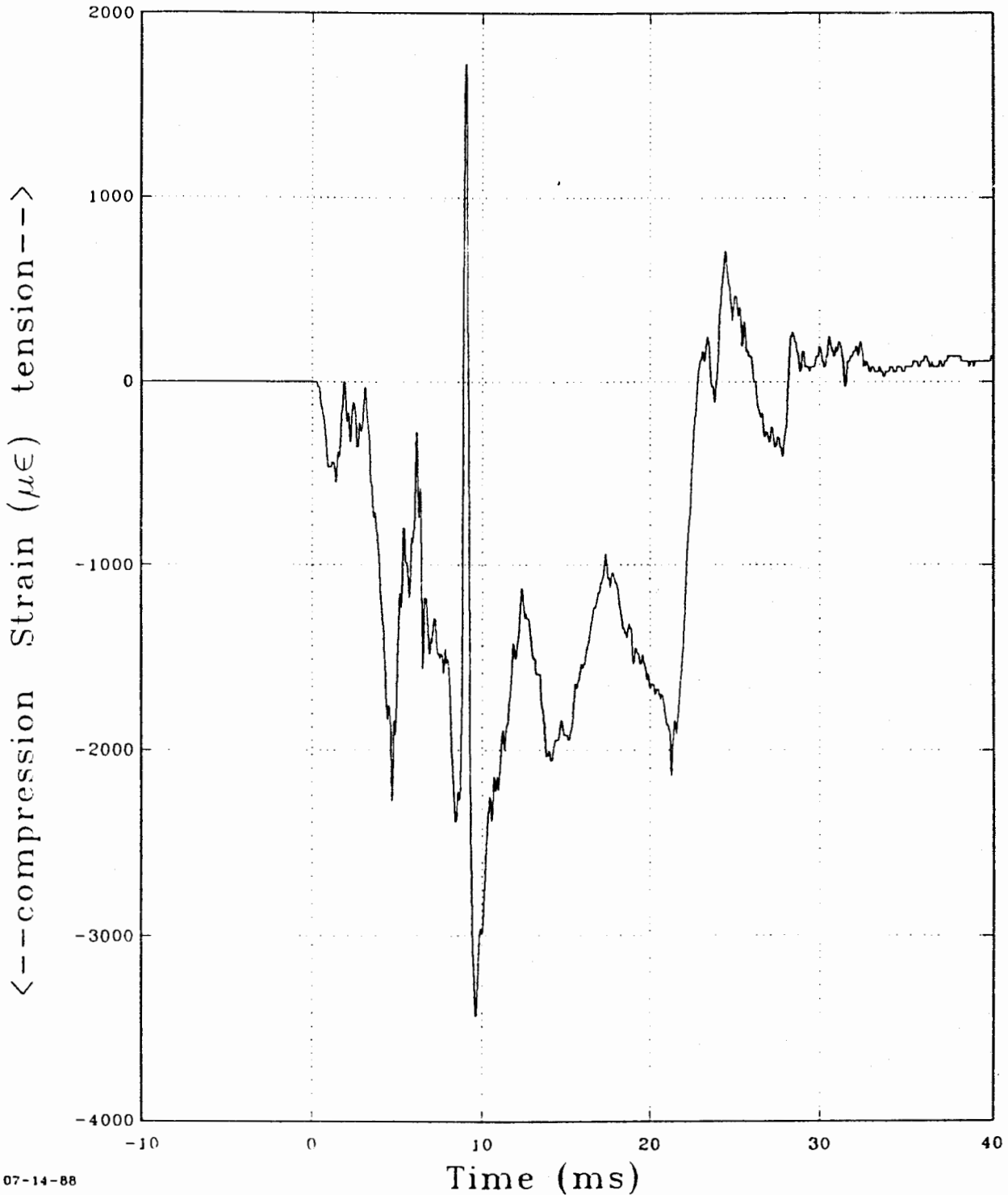

07-14-88

SNLA
5144

~~SECRET~~ UNCLASSIFIED

~~SECRET~~

UNCLASSIFIED

HB-III Helicopter Air Drop Strain at 180 Degrees

Analog LPF: 4800 Hz
Digital LPF: none

Test Date
02-12-88

W61-3
SSP-85

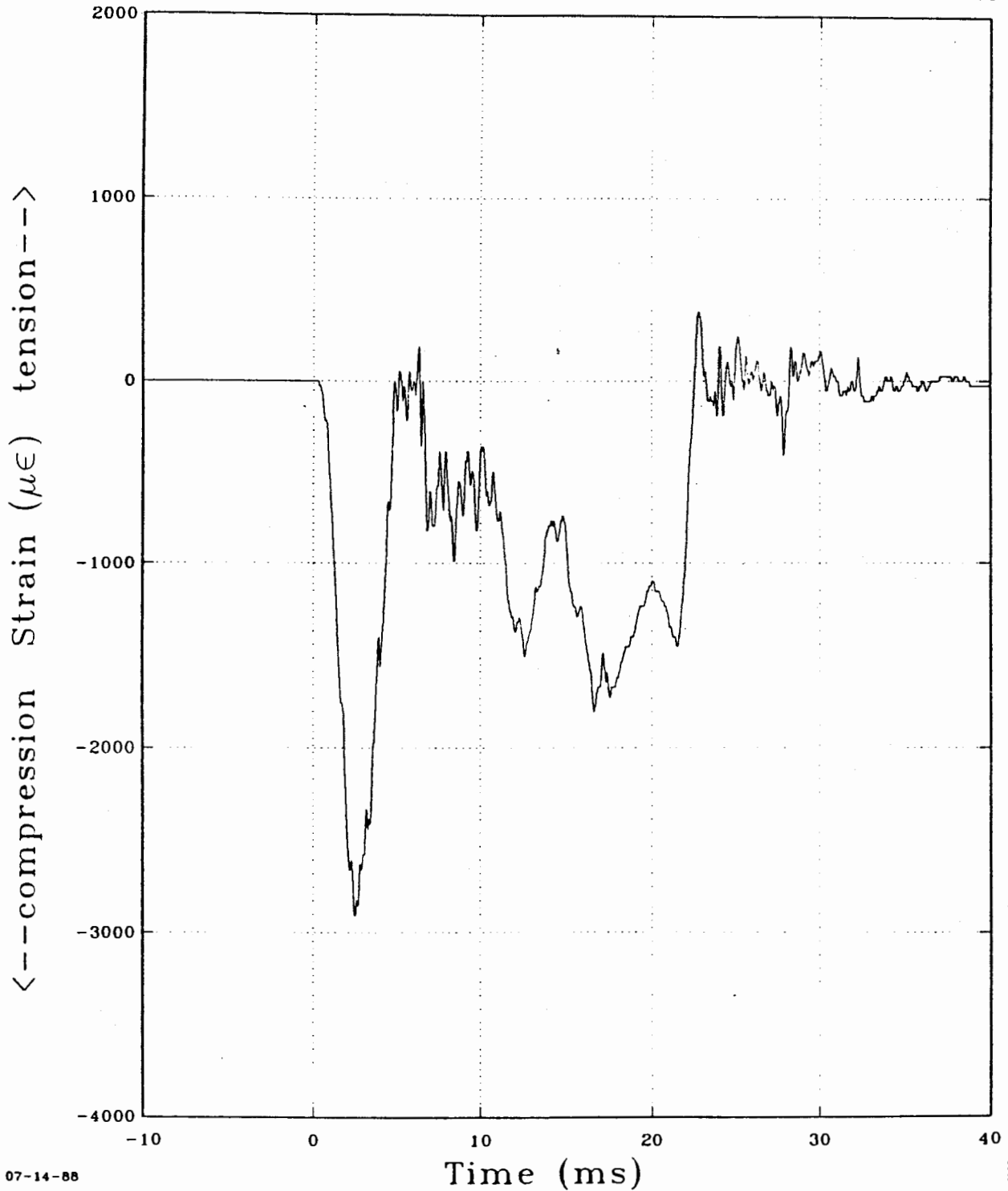

07-14-88

SNLA
5144

~~SECRET~~

UNCLASSIFIED

ACB

UNCLASSIFIED

HB-III Helicopter Air Drop Strain at 270 Degrees

Analog LPF: 4800 Hz
Digital LPF: none

Test Date
02-12-88

W61-3
SSP-85

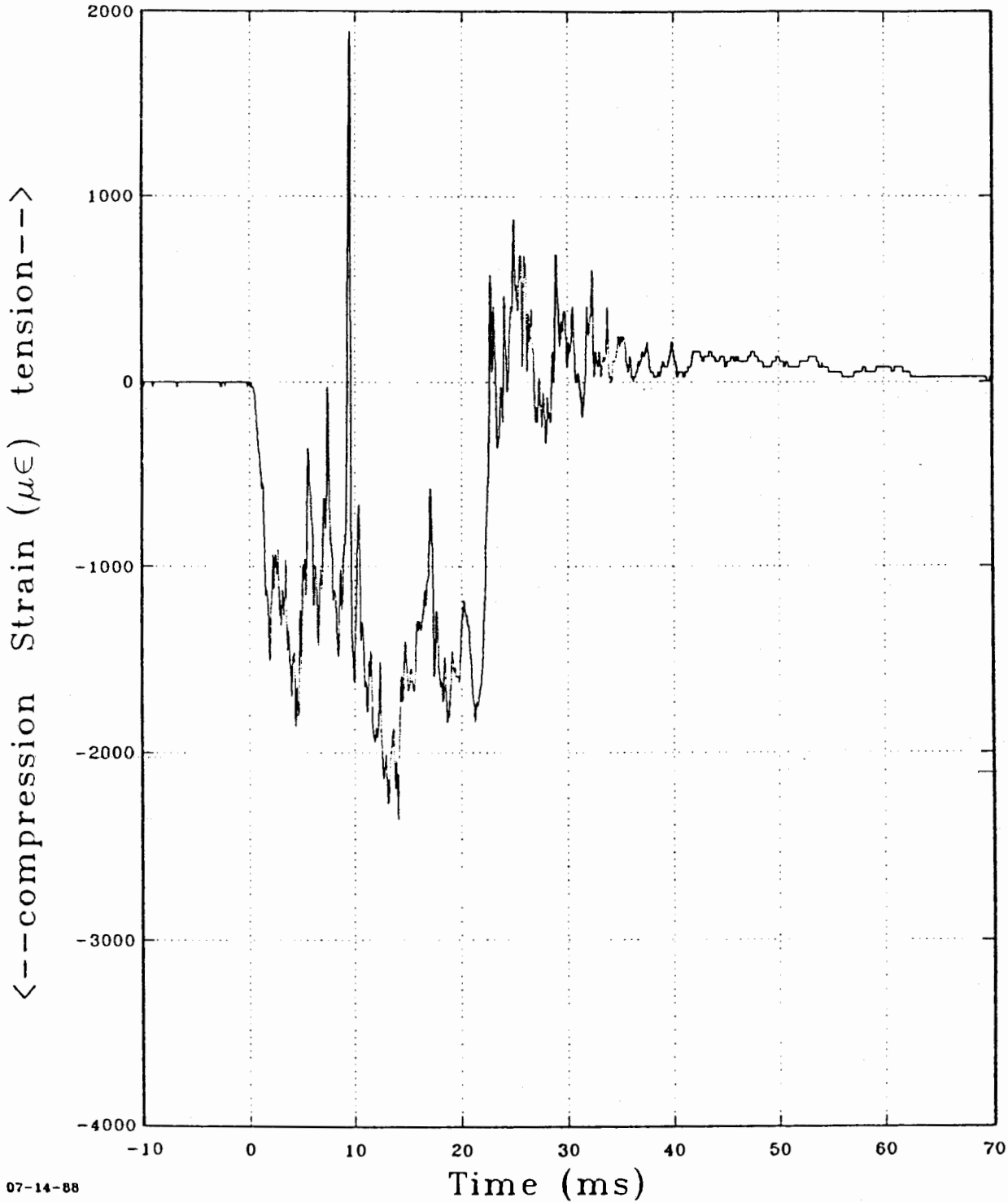

07-14-88

SNLA
5144

ACB

UNCLASSIFIED